

Ultrasonic Calibration of a Magnetic Tracker in a Virtual Reality Space

Morteza Ghazisaedy
David Adamczyk
Daniel J. Sandin
Robert V. Kenyon
Thomas A. DeFanti

Electronic Visualization Laboratory (EVL)
Department of Electrical Engineering and Computer Science
and School of Art and Design
The University of Illinois at Chicago
851 S. Morgan, Room 1120 SEO (M/C 154)
Chicago, IL 60607-7053
(312)996-3002
Email: sandin@eecs.uic.edu

ABSTRACT

This paper describes a system for calibrating the position component of a 6-degree-of-freedom magnetic tracker by comparing the output with a custom-built ultrasonic measuring system. A look-up table, created from the collected difference data, is used to interpolate for corrected values. The error of the resulting corrected magnetic tracker position is measured to be less than 5% over the calibrated range.

Keywords: Virtual reality, CAVE, magnetic tracker, ultrasonic tracker

I. INTRODUCTION

A. Purpose and Motivation

A goal of any virtual reality (VR) system is to make user control of the environment as natural as possible. Accurate tracking is needed for VR systems to generate correctly sized and oriented perspective views, to allow user picking of objects, and to facilitate navigation.

B. Background

There are 3 major types of tracking devices that detect both position and angular orientation.

1 - Mechanical Linkages. Mechanical linkage systems use an arm-like structure composed of several joints with one end fixed and the other end free to move with the user. These devices measure the position and angular orientation of the free end by measuring the angles at each joint of the structure, factoring in the length of each segment. The BOOM by Fake Space Labs uses such a linkage setup well.

Advantages include low latency and the potential of high positional accuracy. Disadvantages derive from the limited extent of movement determined by the total length of the arm, and the inertia of the structure (especially with a BOOM monitor attached) [3]. In addition, using a second mechanical linkage system to capture the user's hand information is highly tangle-prone.

2 - Ultrasonic Systems. Ultrasonic systems have two major components, a transmitter generating an ultrasound signal and a receiver detecting the signal. The distance is calculated by measuring the time-of-flight of the ultrasonic pulse. Three transmitters and receivers are needed to calculate a full 3D position and orientation [2]. A major

disadvantage is that an unobscured path from the transmitter to the receiver needs to be maintained. Two systems that use ultrasonic tracking are the Power Glove manufactured by Mattel and the 3D Mouse by Logitech [3].

3 - Orthogonal Electromagnetic Field. Orthogonal field systems use magnetic fields to determine position and orientation. A transmitter generates electromagnetic signals which are received by a sensor. The strength of the electromagnetic signals are used to determine the absolute position and orientation of the receiver relative to the transmitter. The advantage is that this type of tracker allows arbitrary movement in a relatively large (8 ft. radius) space. On the other hand, such trackers exhibit substantial delay and increased inaccuracy with distance from the transmitter. Two well known versions are the Polhemus 3-Space and the Ascension Flock of Birds.

II. CAVE VR SYSTEM

A. CAVE Overview

The CAVE is a Virtual Reality system developed at the Electronic Visualization Laboratory (EVL) at the University of Illinois at Chicago. The current CAVE is ten feet on a side [4] where two or three walls are rear-projected and the floor is projected down from above. The Ascension Extended Range Transmitter Flock of Birds (ERTFOB) magnetic tracker is used to measure the position of the user's head and a hand-held position device called the "wand."

B. Tracking System

The electromagnetic transmitter has 3 orthogonal coils which are pulsed in sequence. The receiver also contains 3 orthogonal coils which measure the components of the electromagnetic signal. The strength of the 3 components of the received pulse are compared to the strength of the transmitted pulse to determine the position. The strength of the 3 received signals are compared to each other to determine the orientation (thus the receiver coil most parallel to the transmitter coil will give the highest value and the one most orthogonal will give the lowest). For each position, the transmitter sends three pulses, one for each of its coils. The three receiver coils each get 3 pulses, for a total of 9 signals. The range is claimed to be up to an 8 ft. radius from the transmitter. Unfortunately, the accuracy of the system decreases markedly as distance from the sensor to the transmitter increases [4].

Metal structures near the tracker distort the magnetic field, so the CAVE screen frame is made of austenetic

stainless steel which is non-magnetic and has a low conductivity. However, other components needed for the CAVE to function such as projectors and mirrors significantly distort the field [4].

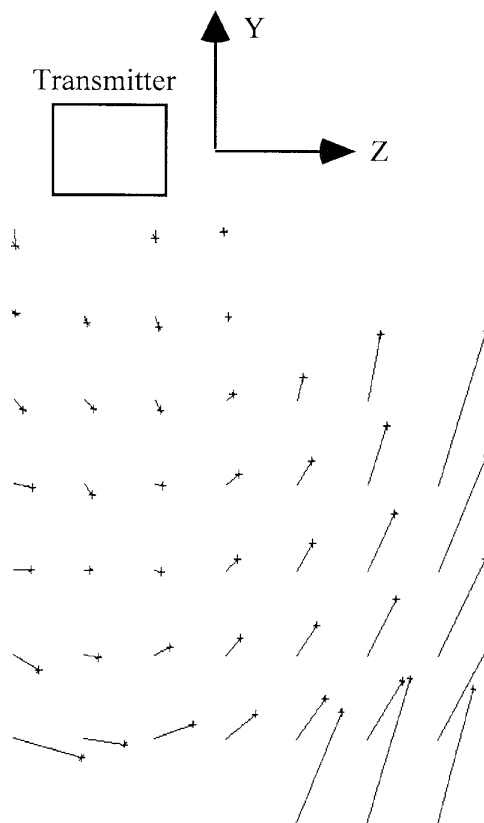

Figure 1. ERTFOB errors in one plane of the CAVE, viewed from the left side. Transmitter is one foot in front of this plane.

III. CALIBRATION METHOD

A. Overview

The goal of the calibration system is to correct for ERTFOB static position errors. For each position reported by the magnetic tracker, the physical position of the sensor is measured using our more accurate ultrasonic measuring device (UMD). A table is built containing positions of the magnetic sensor reported by the ERTFOB and their corresponding positions reported by the UMD. Using this

table, any point within the range can be corrected by interpolation between the corrected points in the calibrated area. The table must be rebuilt whenever the tracking system or the CAVE is moved.

Figure 1 shows the position errors for a plane placed one foot right of center, vertically oriented and perpendicular to the front wall of the CAVE. The positions as measured by the UMD are shown by the x's at the end of the lines whose other ends are the positions as measured by the ERTFOB. Figures 2 and 3 show in 3D all the planes at once. Each figure has two stereograms: the left pair for cross-eyed viewing and the right pair for wall-eyed viewing.

B. The Ultrasonic Measuring Device

The UMD generates an ultrasonic sound signal using a transducer and sends it toward an object. The sound

reflected from the object, or echo, is also detected by the transducer. Distance is obtained by measuring the time interval between the moment the sound is transmitted and the echo is received. The elapsed time between the transmission and echo signal is a linear function of the distance [5].

To measure position in all 3 dimensions, 4 Polaroid ultrasonic transducers are used, one to measure the distance to each wall and the floor of the CAVE. The distance to the left and right walls is measured by two transducers and gives the X coordinate, the distance to the floor gives the Y coordinate, and the distance to the front wall gives the Z coordinate. Two transducers are used redundantly for the X coordinate to detect yaw error by checking that the sum of the two distances (left and right) are equal to the distance across the CAVE (10 ft.). If the sum is the greater than 10 ft., the left and right transducers are not perpendicular to

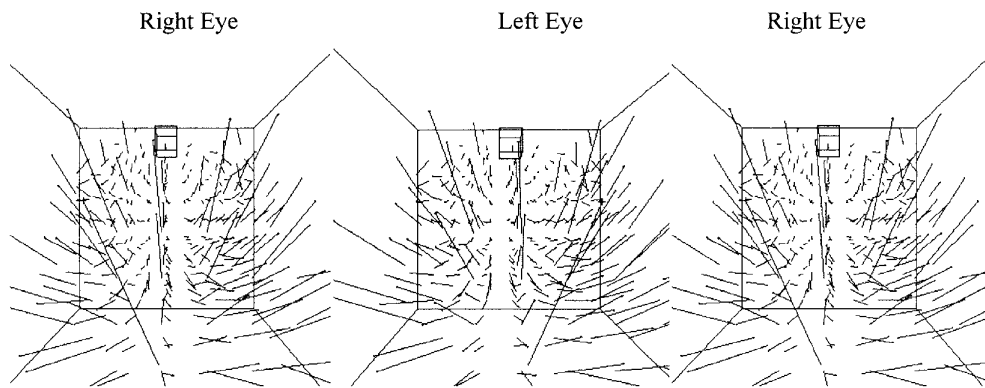

Figure 2. Stereogram of ERTFOB errors viewed from back of CAVE.

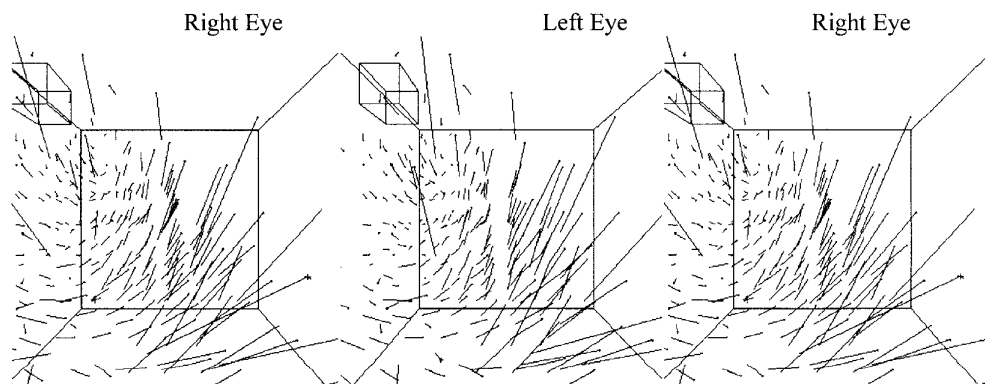

Figure 3. Stereogram of ERTFOB errors viewed from left side of CAVE.

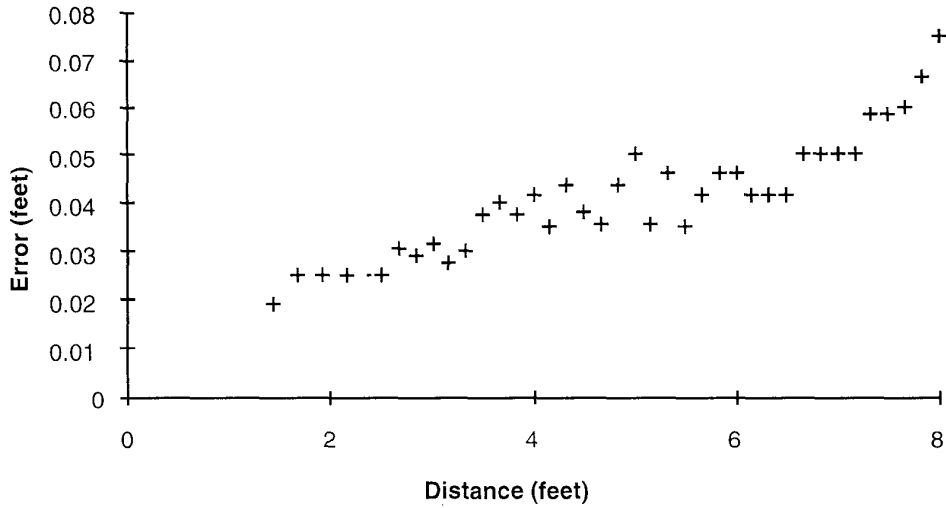

Figure 4: UMD error versus distance.

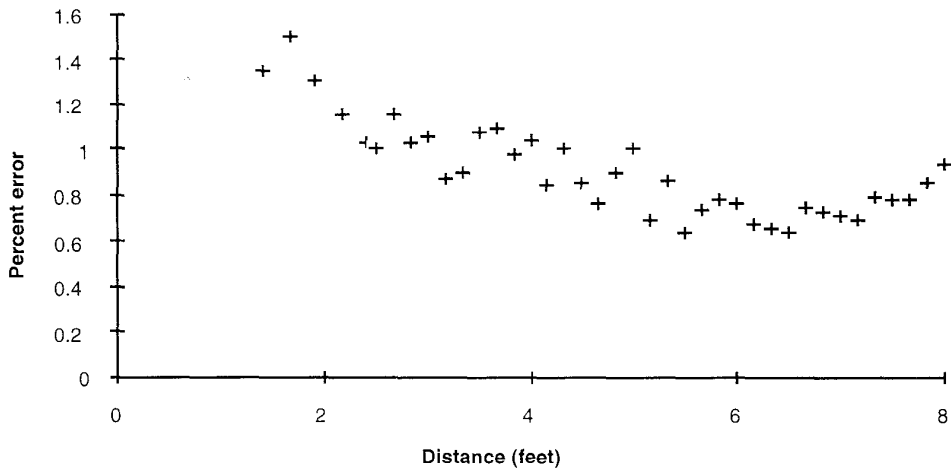

Figure 5: Percent UMD error versus distance.

the CAVE walls. In addition, 4 mercury switches are used for each side of the transducer box as a level. Whenever the transducers are pitched or rolled more than 10 degrees, the system will not record data. The Polaroid transducers report the shortest distance within ± 10 degrees of perpendicular to the target [8].

To calibrate the UMD, we use an optical bench and a target approximately 4 feet square. Using a velocity value of

347 m/s¹, the actual distance and the readings given by the UMD were compared. The overall error of the UMD is less than 1.5% (Figure 5), so in the 10 ft. CAVE, the maximum error computes to be 1.8 inches.

¹ The speed of sound at 0° C is 331m/s. As the temperature increases so does the speed of sound. The relationship between temperature and speed of sound is given by: $V = 20.034 \sqrt{273 + t}$ where V is the speed of sound in meters/second at a temperature t in centigrade [9]. Since the temperature at EVL was 27° C we used the value 347m/s for the speed of sound. If more accuracy is desired, one can measure the temperature and adjust the measured distances accordingly [11].

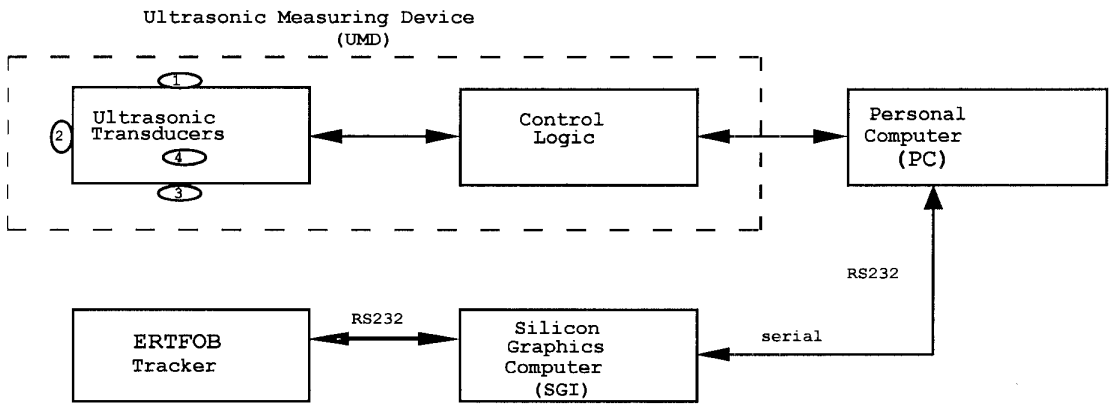

Figure 6: UMD block diagram



Figure 7: Photo of UMD .

The advantages of this ultrasonic measurement system are good linearity over large distances, insensitivity to magnetic fields, more accuracy than the magnetic tracker, and its relatively low cost. Disadvantages include the lack of angular orientation information and the need to keep the transducers parallel to the walls and level (which prevents its use as a primary tracking mechanism, but works well for calibration purposes). In addition, the signal path must not be physically blocked.

Figure 6 shows a block diagram of the entire system [5]. The transducers are controlled by a circuit which uses the Texas Instruments ultrasonic ranging module TI2728 [10]. This circuit, controlled by the PC, sends pulses to each ultrasonic transducer in sequence to eliminate false echoes from the other transducers. It measures the elapsed time between transmitted and received pulses, and then transfers this data to the PC. The PC sends the data to the Onyx CAVE computer through an RS-232 line. The UMD circuitry itself does not affect the magnetic field, because it is located well outside the tracker range and the small UMD box upon which the ERTFOB sits is plastic and contains

only the ultrasonic transducers. Empirical observations bear this out as well.

C. Calibration Procedure

The CAVE is first filled by a 3D stereo graphic image of 1-inch boxes on 1-foot intervals (Figure 8). A 1-inch cursor shows the position of the magnetic sensor which is placed atop the ultrasonic transducer housing. A person wearing 3D glasses holds the UMD reasonably straight and moves it until the displayed cursor is inside of each box. The program records the position given by the ERTFOB and the Onyx sends a signal to the PC to get the position measured by the UMD. This procedure continues until all the boxes in the tracker range inside the CAVE are thus sampled. In practice less than 400 points are collected, essentially all points in the center of the CAVE. The collected points are not exactly at one foot intervals as measured by the ERTFOB, but lie somewhere inside the 1 inch box at that point, since trying to get the cursor on the exact point is nearly impossible. As we show below, this error is largely taken into account.

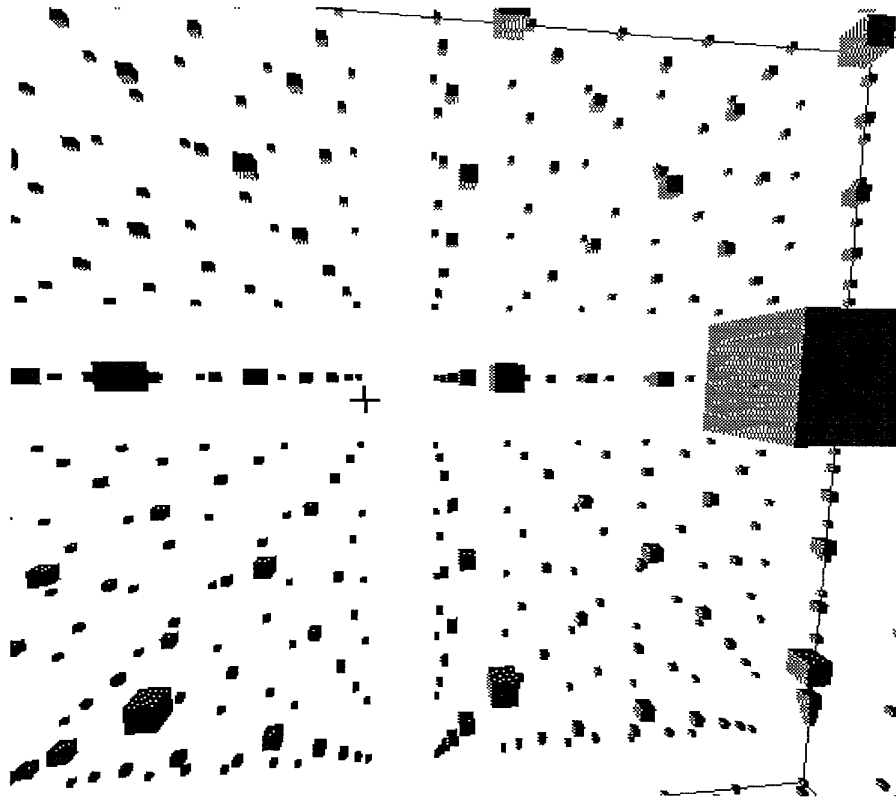

Figure 8: Display in the CAVE of boxes to collect. Cursor (crosshairs) is moved inside boxes to collect point.

IV. CORRECTION METHOD FOR TRACKER

A. Look-Up Table Generation

In previous work [2], the magnetic tracker was moved by constant physical steps and the tracker output was recorded. To create a look-up table of corrections, this data matrix must be inverted. We, instead, create a look-up table of corrections directly by collecting simultaneous tracker output and the actual values as read by the UMD at constant steps. To simplify human performance requirements in the data collection phase, we record data as soon as the tracker is within one inch of the ideal position. Of course, the tracker is measuring how far it is off the mark, so assuming that the tracker is differentially correct for distances of less than an inch, that amount is subtracted from the distances from both the UMD and the ERTFOB. The maximum distance from a collected point to the calibration point is 0.866 inches. We subtract this distance vector from both the UMD and ERTFOB position. Figure 9 shows the 2D case.

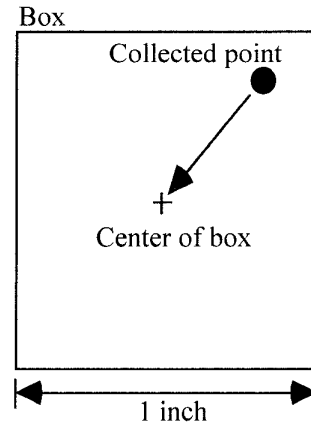

Figure 9: 2D shift. Collected point is shifted by the Cartesian distance to the center of the box

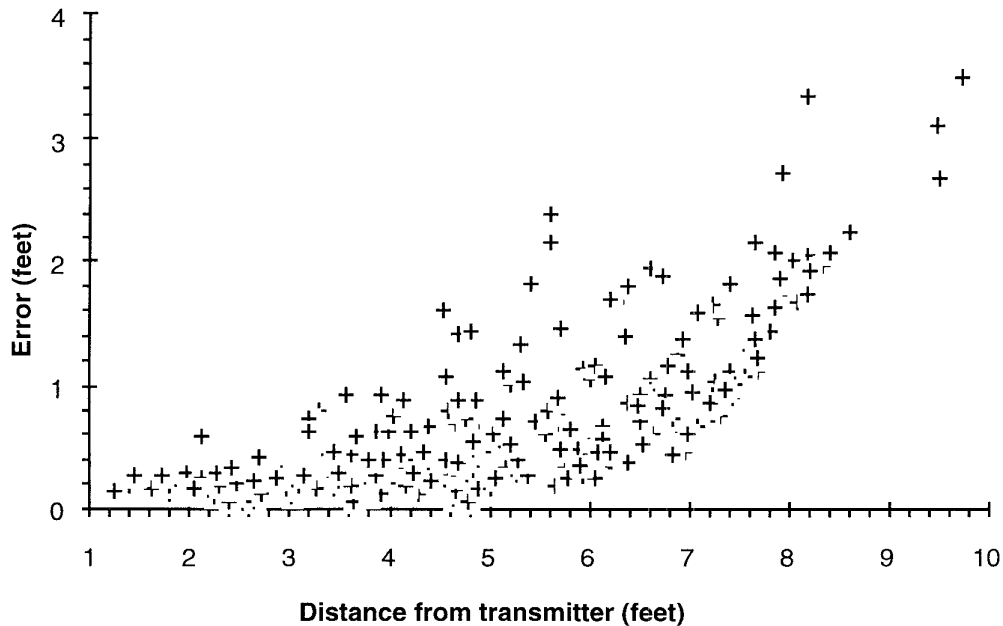

Figure 10 : ERTFOB errors measured

B. Linear Interpolation

The collected points are thus exactly one foot apart; in practice, of course, a continuum of points must be corrected. We assume that the magnetic tracker is linear within one foot intervals. We use trilinear interpolation to calculate corrected values. This procedure is thoroughly described in [9].

C. Results

To measure residual errors after calibration we collected data at one foot intervals on half-foot centers instead of one foot interval on one foot centers. Therefore we measured residual errors half way between the calibration points. These results are shown in Figures 11 and 12 as compared with Figure 10 before correction. These measurements of course depend on the accuracy of the

UMD (less than 1.5% over 10 ft.). The maximum error before calibration is seen to be 4 ft. over a 10 ft. range (40%) (Figure 10). The error after calibrating is 0.27 ft. in the same 10 ft. range (2.7%) (Figure 11). Similarly, the maximum error before calibration is 0.6 ft. in a 3 ft. range (20%) (Figure 10). The error after calibrating is 0.13 ft. over the same range (4.3%) (Figure 11). Clearly, this procedure is better at correcting larger errors than smaller ones, why this is true is not well understood at this point. Minimizing tracker latency is desirable in VR systems, so it is important that the correction computation does not substantially increase existing tracker latency. This linear interpolation method needs 30 additions and 72 multiplications for each correction. On the CAVE Onyx R4400 processor, the above calculation takes less than 10 microseconds [7]. Since the theoretical minimum tracker latency is 21 milliseconds, adding 10 microseconds of delay is negligible.

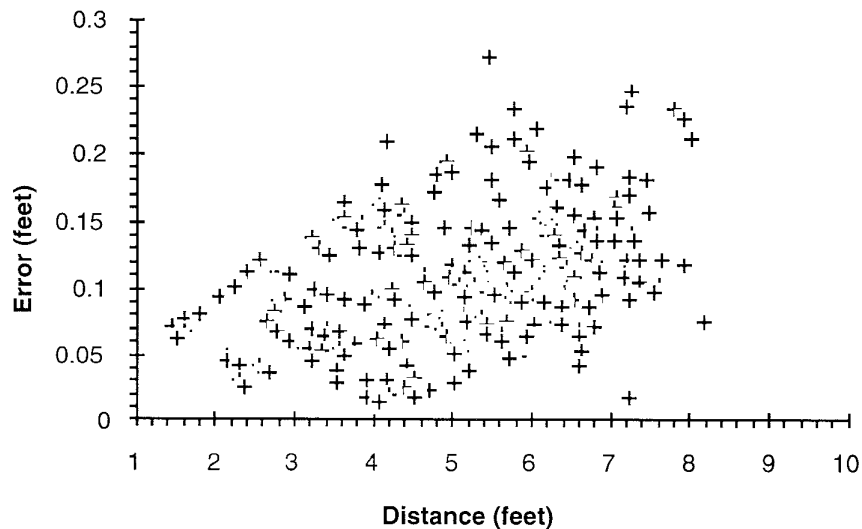

Figure 11: Errors of ERTFOB after correction

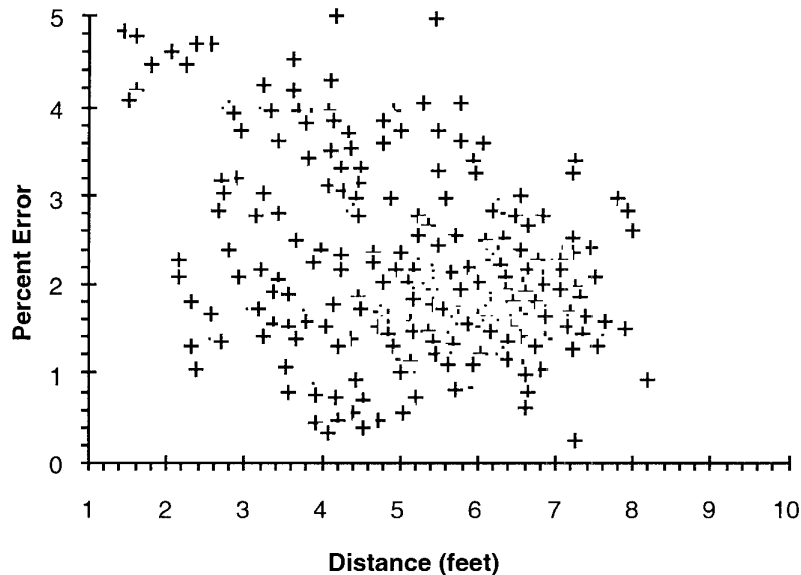

Figure 12: Percentage errors of ERTFOB after correction

V. CONCLUSION

A relatively simple static calibration procedure as outlined above can make a significant improvement in the static accuracy of a magnetic tracking system. This is particularly true when the magnetic fields are distorted by metal in the environment, such as pipes and ducts in the ceiling, and metal reinforcing rods in the floor. For example, a copy of the CAVE installed at Argonne National Laboratories had a somewhat less uncorrected long range error of 2.5 ft. For the installation discussed in this paper, long range errors were reduced from 4 feet to 3.25 inches.

In the CAVE, a physical wand with a ERTFOB receiver attached is used to interact with objects in space, e.g. to pick up or select a virtual object. Often a cursor or graphic extension to this physical wand is used to indicate state of activity or to point to parts of the scene. If there are errors in either the head tract position or the wand position the physical world and the virtual world will not align properly. For instance, objects in the virtual world which should be fixed and stable will move or change size in incorrect ways, as the viewer moves around.

The quality of experience in a virtual reality system is quite dependent on the accuracy of the tracking subsystem. To gain qualitative information about the improvement of performance with position correction, the right half of the CAVE was uncorrected while the left half of the cave was corrected. There was a very significant improvement in the

size and position stability of objects in the virtual scene and extensions to the wand appeared to stay attached to the wand.

The general improvement is very much worth the effort. The hardware for the UMD itself (not counting the PC) is less than \$300.00 in parts. Detailed documentation is available [1, 5]. The calibration procedure takes a person approximately 2 hours to collect 400 points.

A. Application to Other Systems.

The UMD is particularly well suited to the CAVE in that the projection screens form natural reflectors for the sound. In other systems such as Head Mounted Displays, existing walls in a physical room could be used, or temporary walls could be constructed out of any sound reflecting materials.

VI. FUTURE WORK

The assumption of linearity of the ERTBOF for small distances is used in two places in the calibration procedure. Most importantly, linear interpolation is used on one foot centers. We propose to use splines passing through the correction points to generate a larger lookup table to better model the nonlinear magnetic fields. As mentioned in Section IV, we assume that the ERTFOB is differentially correct to make a small correction from 1 ft centers to the recording position of the UMD. As a post process, one

could use the created lookup table to better estimate this differential and create a more accurate table.

We currently are adding inclinometers to measure roll and pitch. It is our intention to use these readings to create a table of corrections for angle as a function of angle and position.

VI. REFERENCES

1. Adamczyk, D., M.S. Project, University of Illinois at Chicago, September, 1994.
2. Bryson, S., *Measurement and calibration of static distortion of position data from 3D trackers*, Computer Graphics Course #43 Notes, SIGGRAPH Conference, 1993.
3. Bryson, S., *Body tracking*, Computer Graphics Course #43 Notes, SIGGRAPH Conference, California, 1993.
4. Cruz-Neira, C., Sandin, D.J., DeFanti, T.A., "Surround-Screen Projection-Based Virtual Reality: The design and Implementation of the CAVE", *Computer Graphics (Proceedings of SIGGRAPH '93)*, ACM SIGGRAPH, August 1993.
5. Ghazisaedy, M., M.S. Project, University of Illinois at Chicago, July, 1994.
6. Gottschalk, S., Hughes, F.J., "Auto calibration for Virtual environments Tracking Hardware," *Computer Graphics (Proceedings of SIGGRAPH '93)*, ACM SIGGRAPH, August 1993.
7. Graphics Library Programming Guide, Silicon Graphics 1993.
8. Polaroid Ultrasonic Transducer Data Sheet, Model No. 607281, Polaroid Corp, Cambridge, MA.
9. Press, W.H., Flannery, B.P., Teukolsky, S.A., Vetterling, W.T., *Numerical Recipes in C*, Cambridge University Press, 1990.
10. *Texas Instruments Databook Linear Circuits, Amplifiers, Comparators, and Special Functions*, Vol. 1, 1989.
11. Wilson, J.D., *Practical Physics*, Sanders College Publisher, 1986.