

Index Assignment for Multichannel Communication under Failure

Tanya Y. Berger-Wolf*, Edward M. Reingold†

December 15, 2001

Abstract. We consider the problem of multiple description scalar quantizers and describing the achievable rate-distortion tuples in that setting. We formulate it as a combinatorial optimization problem of arranging numbers in a matrix to minimize the maximum difference between the largest and the smallest number in any row or column. We develop a technique for deriving lower bounds on the distortion at given channel rates. The approach is constructive, thus allowing an algorithm that gives a closely matching upper bound. For the case of two communication channels with equal rates, the bounds coincide, thus giving the precise lowest achievable distortion at fixed rates. The bounds are within a small constant for higher number of channels. To the best of our knowledge, this is the first result concerning systems with more than two communication channels.

Key words. Multichannel communication, diversity systems, quantization, source coding, multiple descriptions, index assignment, graph bandwidth, hamming graph, cartesian products of cliques, complete graphs, algorithm design.

1 Introduction.

Consider sending information over k independent unreliable channels. We want to partition the source information into k subsets so that if all k subsets are received, the original information can be completely reconstructed, and if any of the channels fail, then the error, defined as the absolute (rather than Hamming) difference between the original information and the possible reconstruction of it, is minimized. Figure 1 shows the general setting of the problem. A trivial solution would be to divide the source information into k equal blocks, sending each over a separate channel. However, if any block fails to arrive, that part of the information is lost completely. The error in this case could strongly depend on which channel was lost, a feature we would like to avoid. Alternatively, we could send k complete copies, so that even if only one of the channels succeeds, all the information is still available. This scheme, while robust, utilizes the resources poorly. Our goal is to partition the information in a way that allows to recover as closely as possible the information originally sent, with the error depending on the number of channels lost.

1.1 Background

The problem of designing codes for a *diversity-based* (multichannel) communication system that guarantee a minimum fidelity at the user end based on the number of channels succeeding in transmitting information, is known as the *Multiple Description problem*. It was introduced by Gersho, Witsenhausen, Wolf, Wyner, Ziv, and Ozarow at the 1979 IEEE Information Theory Workshop. It is a generalization of the classical problem of source coding subject to a *fidelity criterion* [24].

*Department of Computer Science, University of Illinois at Urbana-Champaign, 1304 W. Springfield Avenue, Urbana, Illinois 61801, USA. Supported in part by an NSF Graduate Fellowship and by NSF grant CCR-95-30297. tanyabw@uiuc.edu

†Department of Computer Science, University of Illinois at Urbana-Champaign, 1304 W. Springfield Avenue, Urbana, Illinois 61801, USA. Supported in part by NSF grant CCR-95-30297. reingold@cs.uiuc.edu

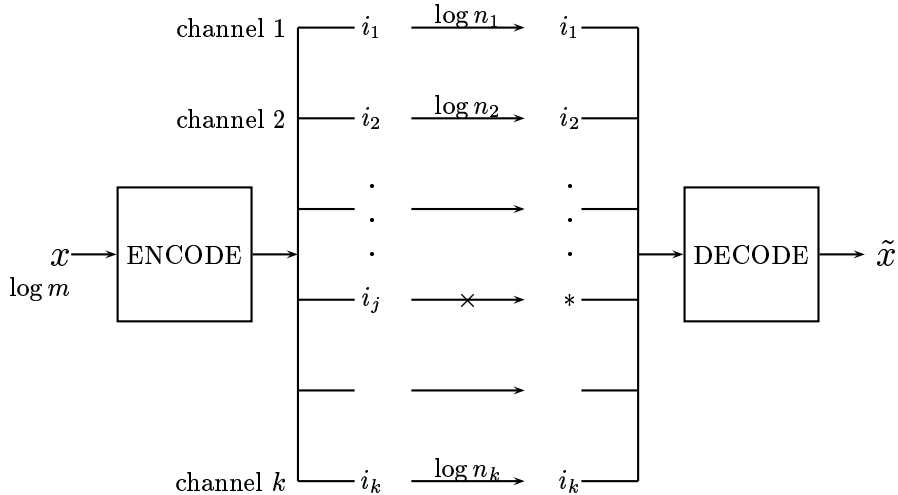

Figure 1: Schematic setting of the multichannel problem.

Initial progress on the Multiple Description problem was made by El-Gamal and Cover [8], who studied the achievable rate region for a memoryless source and a single-letter fidelity criterion. Ozarow [23] showed that the achievable region derived in [8] is the rate-distortion region for the special case of a memoryless Gaussian source and a square-error distortion criterion. Zhang and Berger [33] and Witsenhausen, Wolf, Wyner, and Ziv [30], [31] explored whether the achievable rate region is the rate-distortion region for other types of information sources.

The first constructive results for two channels with equal rates were presented by Vaishampayan [26], [25]. In [26] Vaishampayan designs Multiple Description Scalar Quantizers (MDSQs) with good asymptotic properties. We show, however, that this solution is not optimal.

An MDSQ is a *scalar quantizer* (mapping of the source to a finite integer point set) that is designed to work in a diversity-based communication system. The problem of designing an MDSQ consists of two main components: constructing an *index assignment* (a mapping of an integer source to a tuple to be transmitted) and optimizing the structure of the quantizer for that assignment. This paper focuses on the index assignment part of the problem. We present a general technique for designing index assignments for any number of channels. We give upper and lower bounds for the information distortion for fixed channel rates. In case of two channels transmitting at equal rates, the bounds coincide, thus giving an optimal algorithm for the index assignment problem. In the case of three or more equal-rate channels, the bounds are within a multiplicative constant.

Real applications of the index assignment problem arise in video and speech communication over packet-switched networks, where the information has to be split into several packets which can be lost in transmission resulting in poor signal quality ([17], [18], [32], [2]).

1.2 Problem Statement

We are given a communication system with k channels. Channel i transmits information reliably at a rate $\log n_i$ bits per second. Each channel either succeeds or fails to transmit the information. If a channel fails, all the information transmitted over the channel is lost. If a channel succeeds, the received information is assumed to be correct.

We assume the source to generate integers with uniform distribution, the result of a quantization process. We assume the numbers to be contiguous and refer to them by the indices 0 through $m-1$ for some m . Thus we consider the transmitted information be an integer x with at most $\lg m$ bits, where $1 \leq m \leq n_1 n_2 \cdots n_k$. An (n_1, n_2, \dots, n_k) -level MDSQ maps this x to a unique k -tuple (i_1, \dots, i_k) ; component i_j is sent over the j th channel. If all of the channels succeed, then we should be able to decode x from the k -tuple exactly. If some of the channels fail, we want the encoding to minimize the distortion between the original information and

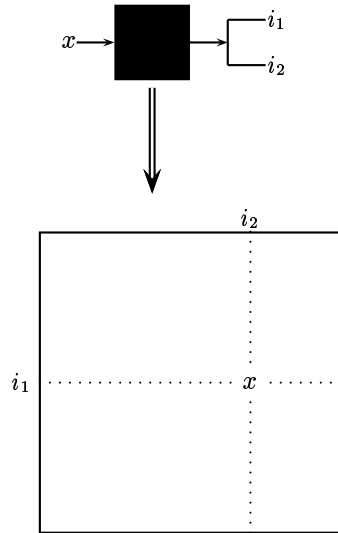

Figure 2: Correspondence between an encoding scheme and arrangement of numbers in a matrix.

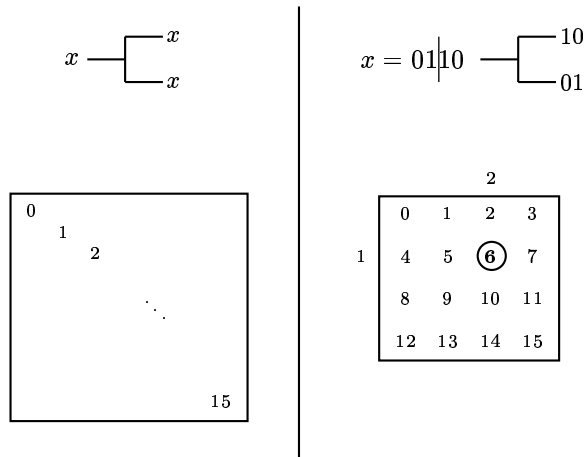

Figure 3: Examples of encoding schemes and the corresponding matrices: *left* - identical copies of the input number are sent over the channels; *right* - the input number is split into blocks of bits, which are sent over the channels.

the reconstructed transmission. The system can be viewed as one encoder

$$f : \{0, \dots, m - 1\} \rightarrow \{0, \dots, n_1 - 1\} \times \dots \times \{0, \dots, n_k - 1\}$$

and $2^k - 1$ decoders, (g_0, \dots, g_{2^k-2}) , each dealing with a unique subset of successful channels, with at least one succeeding channel. Let g_0 be the decoder with all channels succeeding and let D_t is the distortion rate of the set of channels represented binary by t , a 1 corresponding to failure. The problem we are interested then is describing the rate-distortion tuples

$$(\log n_1, \log n_2, \dots, \log n_k; \quad 0, D_1, \dots, D_{2^k-2}),$$

This is a generalization of the notation used for two channels, where the rate distortion tuples are specified by $(R_1, R_2; D_0, D_1, D_2)$. Here R_1 and R_2 are the transmission rates of the two channels, D_0 is the distortion in case both channels succeed, D_1 is the distortion in case of the first channel failure, and D_2 is the distortion in case of the second channel failure.

Consider the available information in case of channel failure. If some of the channels fail, the remaining successful channels imply upper and lower bounds on x , namely the largest and the smallest values among those consistent with the successful components of x . For example, when $k = 2$, x is mapped to a pair (i_1, i_2) . If the first channel fails, we know that x is between the smallest and the largest numbers having second component i_2 . Similarly, if the second channel fails, x is between the smallest and the largest numbers having first component i_1 . Thus, designing a code to minimize distortion in case of any l channels failing in a system with a contiguous source dictionary of size m and k channels, channel i transmitting reliably at rate $\log n_i$, is equivalent to the combinatorial problem of putting numbers $X = \{0, \dots, m - 1\}$ into a k -dimensional matrix, dimension i being of size n_i , to minimize the difference between the smallest and the largest number in each full l -dimensional submatrix. This correspondence is shown in Figures 2 and 3. In this paper we will be working with the combinatorial version of the problem.

The problem is also equivalent to minimizing graph bandwidth of a k -fold cartesian product of cliques (Hamming graph) and induced subgraphs of it. There is a large body of research dedicated to the bandwidth of various graphs. There are two possible simplifications of the Hamming graph bandwidth problem: either small cliques, or few cliques. In 1966 Harper [14] stated the bandwidth problem for a k -dimensional

hypercube, the cartesian product of k cliques of size 2. Hendrich and Stiebitz [16] solved the problem for cartesian product of two cliques of equal size. We propose a vertex labeling of the cartesian product of an arbitrary number of cliques of arbitrary (equal) size. To the best of our knowledge, this result gives the best upper bound on the bandwidth of products of more than two cliques of size greater than 2.

For a survey on the topic of graph bandwidth up to 1982, see [7]. For a recent survey on Harper-type techniques on graphs see [4]. For more information on the subject of graph bandwidth see West, [28].

1.3 Notation and Terminology

- *Arrangement* – the inverse of encoding, that is a function from the cells of the matrix to the numbers to be put in those cells:

$$A : I \rightarrow \{1, \dots, m\},$$

where I is a subset of the product of the sets of indices $I_1 \times \dots \times I_k$.

- *Slice* – a full submatrix. An l -dimensional slice is a subset of all cells with $k - l$ coordinates fixed:

$$(*, \dots, *, i_{j_1}, *, \dots, *, i_{j_2}, *, \dots, *, i_{j_{k-l}}, *, \dots, *).$$

- *Line* – a one-dimensional slice:

$$(i_1, i_2, \dots, *, \dots, i_k).$$

- *Spread* – the difference between the largest and the smallest number in a slice.
- *Maximum spread* of an arrangement, $spread(A)$, – the maximum over all the spreads in slices of the same fixed dimension.
- *Smalls* – a plural form of “the smallest number”, a set of the smallest numbers in a set of slices.
- *Bigs* – similar to smalls, a plural form of “the largest number”.

2 Results

We design a technique that provides a lower bound on the maximum spread in a line in any arrangement of the numbers $X = \{0, \dots, m - 1\}$ in a k -dimensional matrix. The technique is constructive, which allows us to design an algorithm that gives an upper bound.

We consider the case of equal channel capacities, so that the corresponding k -dimensional matrix is a cube. First, the lower bound and the algorithm are derived for the case of only one channel failing. In Section 2.2 we show the results for an arbitrary number of channels failing. The k -channel problem thus reduces to finding an arrangement of the m numbers in an $n \times \dots \times n$ k -dimensional matrix that minimizes the maximum spread in a line.

The idea of the lower bound proof is as follows:

1. For any possible arrangement A of $X = \{0, \dots, m - 1\}$ in the matrix, consider the sorted (in ascending order) list of smalls in all lines, $small(A)$. If a number is the smallest one in more than one line, than it appears in this list more than once. For example, 0 always appears k times and any $small(A)$ list starts with k zeros. The goal is to find a bounding sequence of smalls that is at least as large elementwise as any such smalls list. Then the j th smallest number in a line in any arrangement, $small(A)_j$, is at most the j th member of the bounding sequence. Let $\langle a \rangle = \langle a_1, a_2, \dots \rangle$ be the bounding sequence; then the following must hold for all j :

$$a_j = \max_A \{small(A)_j\}.$$

We will show in Lemma 1 that there exists an arrangement whose smalls list realizes the bounding sequence.

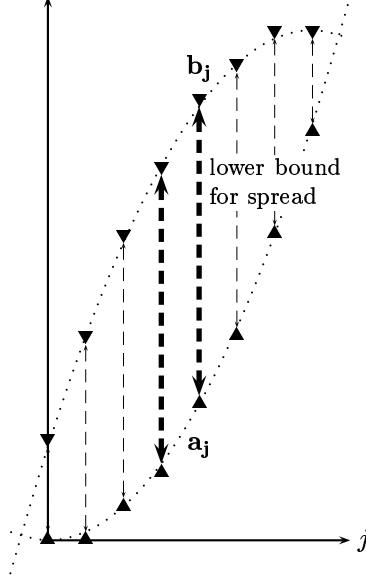

Figure 4: The process of derivation of the lower bound on spread.

2. Similar to the smalls, find a bounding sequence of bigs that is elementwise at most any bigs list, $big(A)$, produced by any arrangement. Let $\langle b \rangle = \langle b_1, b_2, \dots \rangle$ be the bounding bigs sequence; then the following must hold for all j :

$$b_j = \min_A \{big(A)_j\}.$$

Lemma 1 shows that there exists an arrangement whose bigs list realizes the bounding sequence.

3. Maximum pairwise difference of the bigs and smalls lists of an arrangement is a lower bound on the maximum spread of the arrangement, $spread(A)$. That is, for all A

$$\max_j \{big(A)_j - small(A)_j\} \leq spread(A).$$

This statement is known as the Ski Instructor problem and the proof can be found in [21].

Since for the bounding sequences $\langle b \rangle$ and $\langle a \rangle$ we have $b_j \leq big(A)_j$ and $a_j \geq small(A)_j$ for all A and j , then pairing smaller b_j with smaller a_j gives a lower bound on the spread for all possible arrangements. For all A :

$$\max_j (b_j - a_j) \leq \max_j \{big(A)_j - small(A)_j\} \leq spread(A).$$

The process is shown schematically in Figure 4.

Thus, the main focus of our proof is finding good bounding sequences. Consider the smalls sequence. Suppose we have an initial segment of the bounding smalls sequence, $\langle a_1, a_2, \dots, a_j \rangle$, and are now concerned with the next element in that sequence. We place the elements of X in increasing order into the cells. Notice that every cell in the matrix is an intersection of k -lines. The key observation to maximizing the smalls sequence is that if x is a value in some cell, then x is the smallest number in every line that does not already have an element smaller than x . For example, if we put x into a cell that is an intersection of lines that do not currently have any elements in them, then x is the smallest number in all k lines, and thus appears in the smalls sequence k times. On the other hand, if all k lines already have numbers less than x , then it does not appear in the smalls sequence at all, and the next candidate for the sequence member is at least $x + 1$. In general, if s out of k lines have elements less than x , then x appears in the smalls sequence exactly $k - s$ times. Therefore, to maximize the next element of the smalls sequence we put x into a cell with the largest number of lines in its intersection that have elements less than x . Given a choice, we would also like to put

x_1	x_2	*
*	*	

Figure 5: Let x_1 and x_2 be the elements less than x that already have been placed. All cells marked * are intersections of two lines, one of which already has a number smaller than x . However putting x in the cell below x_1 or x_2 will produce one cell that is an intersection of two lines, both of which have a smaller number. Thus we favor those over the cell to the right of x_2 , since placing x there results only in cells with at most one smaller number in their intersection.

x in a cell that reduces the number of lines without smaller values for the subsequent elements. An example of such placement is shown in Figure 5.

We now demonstrate the lower bound proof and give an arrangement for some special cases.

2.1 The Completely Filled Cube

Assume that the matrix is cube, so $n_i = n$ for all i and the number of elements to be placed in the matrix is $m = n^k$. This corresponds to all channels capacities being equal and the numbers to be transmitted over the channels have number of bits up to the sum of the number of bits that can be transmitted over each channel. That is, there is no redundancy in the system. From the rate-distortion point of view, this corresponds to tuples of type $(\log n, \log n, \dots, \log n; 0, D_1, \dots, D_{2^{k-1}})$.

2.1.1 Herringbone Arrangement

We now define the arrangement that produces a bounding smalls sequence for the cubic matrix. In fact, this arrangement produces a bounding smalls sequence for a more general class of completely filled rectangular matrices, the cube being a special case.

Definition 1. A *herringbone arrangement* of a k -dimensional $n_1 \times n_2 \times \dots \times n_k$ completely filled matrix is defined recursively as follows. Assign an arbitrary order to the coordinates of the system (i_1, i_2, \dots, i_k) .

A herringbone arrangement of $0 \times \dots \times 0$ k -dimensional matrix is empty. A herringbone arrangement of $1 \times \dots \times 1$ k -dimensional matrix is the number 0 placed in a single cell.

A herringbone arrangement of a 0-dimensional matrix is also the number 0 placed in a single cell.

Given a herringbone arrangement of $t_1 \times t_2 \times \dots \times t_k$ k -dimensional matrix (that is the cells of the matrix are filled up to the coordinate $t_i - 1$ in dimension i), we define a larger herringbone arrangement recursively:

- project the existing arrangement onto the $(k - 1)$ -dimensional slices adjacent to the existing arrangement,
- calculate the $(k - 1)$ -dimensional volume of each projection,
- recursively fill the largest volume projection (using coordinate order to break ties) with the herringbone arrangement for $k - 1$ dimensions.

Examples of 2 and 3-dimensional arrangements are shown in Figure 6. The name “herringbone arrangement” is due to the herringbone-like pattern seen clearly in two dimensions. We denote the element in the cell (i_1, \dots, i_k) of the k -dimensional herringbone arrangement by $HB_k(i_1, \dots, i_k)$. Let $i_{\max} = i_p$. If there is more than one coordinate with the maximum value, take the largest coordinate. Then

$$HB_k(i_1, \dots, i_k) = (i_p + 1)^{(p-1)} \cdot i_p^{(k-p+1)} + HB_{k-1}(i_1, \dots, i_{p-1}, i_{p+1}, \dots, i_k).$$

The last equality follows from the recursive definition of the herringbone arrangement. The herringbone arrangement fills the matrix in layers, the maximum coordinate value indicates in which layer of the arrangement is the cell. Thus the value in a cell is in the i_p 'th layer, the first $i_p - 1$ layers being completely

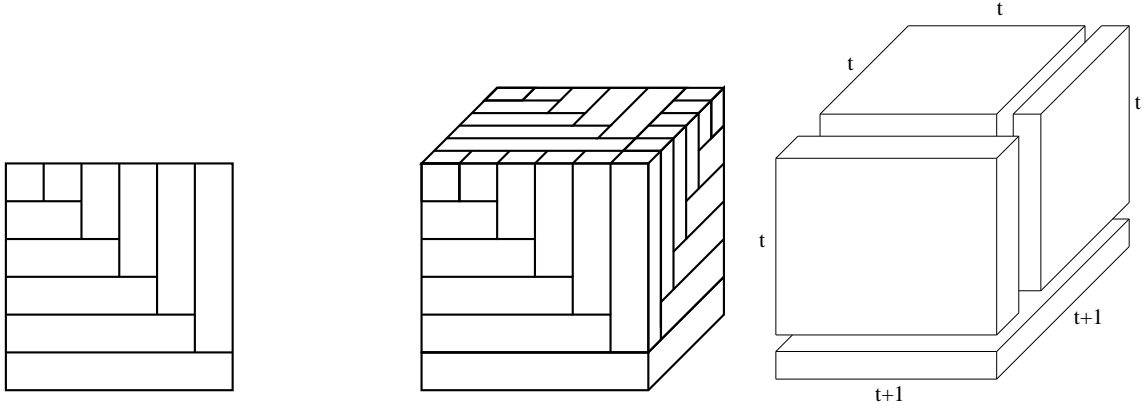

Figure 6: An example of herringbone arrangements in 2 and 3-dimensional matrices.

filled and the element is within a $(k - 1)$ -dimensional submatrix, recursively filled with the herringbone arrangement.

We can also write explicitly the invese of the k -dimensional herringbone arrangement:

$$HB_k^{-1} : \mathcal{N} \rightarrow I^k$$

Let $t = \lceil \sqrt[k]{m} \rceil$. For $(t - 1)^{k-j+1}t^{j-1} < m \leq (t - 1)^{k-j}t^j$ for some $1 \leq j \leq k$

$$HB_k^{-1}(m) = (i_1, \dots, i_j, \dots, i_k),$$

where $i_j = t$ and $(i_1, \dots, i_{j-1}, i_{j+1}, \dots, i_k) = HB_{k-1}^{-1}(m - (t - 1)^k)$.

That is,

$$HB_k^{-1}(m) = \begin{cases} (t, HB_{k-1}^{-1}(m - (t - 1)^k), & \text{if } (t - 1)^k < m \leq (t - 1)^{k-1}t \\ (\square, t, \square, \dots, \square), & \text{if } (t - 1)^{k-1}t < m \leq (t - 1)^{k-2}t^2 \\ \dots & \\ (\square, \dots, \square, \square, t), & \text{if } (t - 1)t^{k-1} < m \leq t^k \end{cases}$$

where the coordinates indicated by boxes form $HB_{k-1}^{-1}(m - (t - 1)^k)$.

For example, when $k = 2$, the two-dimensional herringbone arrangement is defined as

$$HB_2^{-1} : \mathcal{N} \rightarrow I \times I$$

$$HB_2^{-1}(m) = \begin{cases} (\lceil \sqrt{m} \rceil, m - (\lceil \sqrt{m} \rceil - 1)^2), & \text{if } m \leq (\lceil \sqrt{m} \rceil - 1)\lceil \sqrt{m} \rceil \\ (m - (\lceil \sqrt{m} \rceil - 1)\lceil \sqrt{m} \rceil, \lceil \sqrt{m} \rceil), & \text{otherwise} \end{cases}$$

2.1.2 The Lower Bound

Now we show that the herringbone arrangement is the one we need.

Lemma 1. *The herringbone arrangement of values in a k -dimensional matrix maximizes the smalls sequence – the ascending list of lines' smallest numbers – for that matrix.*

Proof. The proof is a generalization of Harper's proof of the main theorem in [13]. We use induction on k and the largest dimension size, $n_{\max} = \max_i \{n_i\}$.

The base cases of $k = 0$ and $n_{\max} = 1$ are trivial.

Suppose we have a matrix with the largest dimension size n_{\max} (largest coordinate value $n_{\max} - 1$). By the induction hypothesis, the herringbone arrangement maximizes the smalls sequence in the k -dimensional matrix up to the coordinate value $n_{\max} - 2$ in every dimension, that is, it maximizes the initial segment of the smalls sequence for the entire matrix.

Consider the smallest element x which has not yet been used in the arrangement. As we have noted before, every cell in the matrix is an intersection of k lines. We shall call a line *protected* if it has a smallest number in it. Since we are placing numbers in the increasing order, this means a line is protected if it has any number in it. When we put x in any cell, it will be the smallest number in any unprotected line in its

intersection. Thus the goal is to put x into a cell that is an intersection of as many as possible protected lines. However, since we have a complete herringbone arrangement of a smaller cube matrix, any free cell has at most one protected line in its intersection. The cells that have one protected line are precisely the cells that lie in the lines that intersect a face of the existing herringbone arrangement. Consider now all the lines that intersect a face. After placing the first element in any of these lines, there always exists a cell that is an intersection of at least two protected lines. Thus, once started, one must stay with the same face to ensure larger elements in the smalls list. Notice, that the cells that are being filled are exactly a $(k-1)$ -dimensional projection of a face of a herringbone arrangement, that is a $(k-1)$ -dimensional matrix. Thus by induction hypothesis it is filled with a herringbone arrangement.

The question that remains is what should be the starting face. Notice, that one of the properties of the herringbone arrangement is that at any point the sizes of the available faces differ by at most 1 in any dimension, and they can differ in at most one dimension. Suppose we have one face F_1 of size $t_1 \times \cdots \times t_i \times \cdots \times t_k$ and another face F_2 of size $t_1 \times \cdots \times t_i + 1 \times \cdots \times t_k$. It is easy to see that the smalls sequence produced by filling the face F_1 agrees with the initial segment of the smalls sequence of F_2 , assuming that they are filled with the same numbers. The first difference is in the number that comes after filling the face F_1 . In the first case, it goes onto a new face and thus appears in the smalls sequence $k-1$ times. However, since the face F_2 is bigger, the same element will still be within the F_2 face, albeit in a new $(k-2)$ -dimensional submatrix and hence will appear in the sequence only $k-2$ times. Therefore, to maximize the smalls sequence we must first fill the face with the largest volume of the projection.

The above arguments produce, by Definition 1, a herringbone arrangement. \square

Consider now the complementary arrangement that starts with the largest coordinate of the cube and the largest number and then fills the cube with the herringbone arrangement using the numbers in the descending order. It is easy to see that his complementary arrangement maximizes the bigs arrangement for a k -dimensional cube.

We are now ready to give a lower bound on the spread in a completely filled cube.

Theorem 1. *The spread in a completely filled cube is at least*

$$n^k - 1 - \left\lfloor \left(\frac{kn^{k-1} + 2}{2k} \right)^{\frac{k}{k-1}} \right\rfloor - \left\lfloor \left(\frac{kn^{k-1}}{2k} \right)^{\frac{k}{k-1}} \right\rfloor.$$

Proof. By Lemma 1, herringbone arrangement of a completely filled cube maximizes the smalls sequence. As we have noted, the complimentary arrangement minimizes the bigs sequences.

Since for any arrangement of the elements in the matrix, we know the bounding sequences a_j and b_j , the spread for any arrangement is at least $\max_j \{b_j - a_j\}$. The closed formula for a_j is unusably complicated. However, consider the case of $j = kt^{k-1}$ for some t . In this case a_j is the minimum in the first line after filling a subcube with sides of size t , that is $a_j = t^k = (j/k)^{\frac{k}{k-1}}$. Thus $\lfloor (j/k)^{\frac{k}{k-1}} \rfloor$ is a crude overestimate of any a_j (rounding up to the closest t^k) that coincides with a_j in infinitely many values. The sequence b_j is complementary of a_j . There are kn^{k-1} lines in a k -dimensional cube, therefore there are kn^{k-1} elements in the smalls and bigs sequences, therefore the index complimentary to j in the sequence is $kn^{k-1} - j + 1$ and

$$b_j = n^k - 1 - a_{kn^{k-1}-j+1} \geq n^k - 1 - \lfloor ((kn^{k-1} - j + 1)/k)^{\frac{k}{k-1}} \rfloor.$$

Since the sequences b_j and a_j are complimentary and a_j is convex, then b_j is concave and $\max_j \{b_j - a_j\}$ is achieved in the middle of the sequence, that is, when $j = kn^{k-1}/2$.

$$\begin{aligned} \max_j \{b_j - a_j\} &\geq b_{kn^{k-1}/2} - a_{kn^{k-1}/2} \\ &= \left(n^k - 1 - \left\lfloor \left(\frac{kn^{k-1} - \frac{kn^{k-1}}{2} + 1}{k} \right)^{\frac{k}{k-1}} \right\rfloor \right) - \left(\left\lfloor \left(\frac{kn^{k-1}}{2k} \right)^{\frac{k}{k-1}} \right\rfloor \right) \\ &= n^k - 1 - \left\lfloor \left(\frac{kn^{k-1} + 2}{2k} \right)^{\frac{k}{k-1}} \right\rfloor - \left\lfloor \left(\frac{kn^{k-1}}{2k} \right)^{\frac{k}{k-1}} \right\rfloor \end{aligned}$$

□

Note, that this lower bound is weak. It is not sufficient to merely find the maximum difference between the ordered minima and maxima sequences. There are more constraints that apply to the matching up of the sequences that can give a higher lower bound. We will discuss some of them later. However for the case of two dimensions this lower bound is sufficient and we can compute it exactly.

Corollary 1. *The sread in a completely filled 2-dimensional cube is at least*

$$\frac{n(n+1)}{2} - 1.$$

Proof. From the definition of the 2-dimensional herringbone arrangement, the smalls sequence for a square is

$$\begin{aligned} a_j &= \begin{cases} \lfloor j/2 \rfloor^2 & \text{if } j \text{ is odd,} \\ (j/2 - 1)^2 + j/2 & \text{if } j \text{ is even.} \end{cases} \\ &= \left\lfloor \left(\frac{j-1}{2} \right)^2 \right\rfloor \end{aligned}$$

The bigs sequence is complimentary to the smalls sequence and is

$$b_j = n^2 - 1 - a_{2n-j+1} = n^2 - 1 - \left\lfloor \left(\frac{2n-j+1-1}{2} \right)^2 \right\rfloor$$

thus the difference $b_j - a_j$ is

$$n^2 - 1 - \left\lfloor \left(\frac{2n-j}{2} \right)^2 \right\rfloor - \left\lfloor \left(\frac{j-1}{2} \right)^2 \right\rfloor.$$

By doing the calculations for even and odd cases of j , we find that the integer value of $j = n$ maximizes the expression $b_j - a_j$ and

$$\max_j \{b_j - a_j\} = \frac{n(n+1)}{2} - 1.$$

□

2.1.3 The algorithm

The idea of the algorithm is to put the two complimentary herringbone arrangements together, without increasing the spread. Consider all the ways of merging the two arrangements in a cube. Assuming that the smalls arrangement starts at the $(0, 0, \dots, 0)$ corner, and the complimentary bigs arrangement starts at the $(n-1, \dots, n-1)$ corner, the possibilities are defined by the order of the coordinates in building each arrangement. Thus there are $k!$ possibilities. First, assume for now that we can literally merge the two herringbone arrangements by putting two numbers in every cell of the matrix. In every line, to calculate the spread, the smallest number will be taken from the smalls herringbone arrangement and the largest—from the bigs arrangement. Consider any line in the cube and the corresponding smallest and largest numbers that are defined by the merging permutation. Similar to an earlier argument, the maximum difference between the smallest and the largest numbers in a line occurs in the middle lines, that is the lines of the type $(\lfloor (n-1)/2 \rfloor, \dots, *, \dots, \lfloor (n-1)/2 \rfloor)$. We shall call it Pr_p if p is the non-fixed coordinate. Thus to find the best permutation we calculate the following:

$$\begin{aligned} \min_{\pi \in Perm} \max_{1 \leq p \leq k} \{HB_{\max}(Pr_p) - HB_{\min}(Pr_p)\} &= \min_{\pi \in Perm} \max_{1 \leq p \leq k} \{n^k - 1 - (HB_{\min}(Pr_{\pi(p)}) + HB_{\min}(Pr_p))\} \\ &= n^k - 1 - \max_{\pi \in Perm} \min_{1 \leq p \leq k} \{HB_{\min}(Pr_{\pi(p)}) + HB_{\min}(Pr_p)\} \\ &= n^k - 1 - (HB_{\min}(Pr_1) + HB_{\min}(Pr_k)) \end{aligned} \quad (1)$$

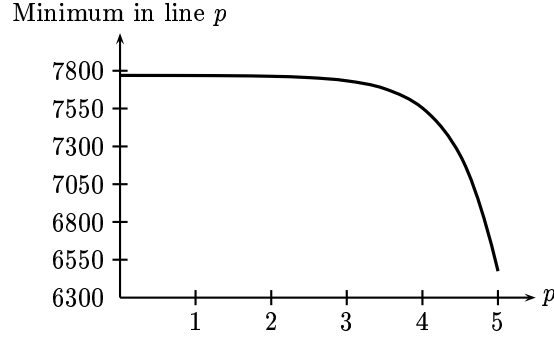

Figure 7: The minimum in line p of the Herringbone arrangement as a function of p , shown here for $n = 11$ and $k = 5$.

To see why equation 1 is true let's look at the smallest number in Pr_p of the herringbone arrangement as a function of p . We shall show the calculations for odd n . The algebra for even n is similar, and the result is the same.

$$\begin{aligned}
HB_{\min}(Pr_p) &= HB\left(\frac{n-1}{2}, \dots, 0, \dots, \frac{n-1}{2}\right), \text{ where } 0 \text{ is in coordinate } p \\
&= \left(\frac{n+1}{2}\right)^{k-1} \left(\frac{n-1}{2}\right) + \left(\frac{n+1}{2}\right)^{k-2} \left(\frac{n-1}{2}\right) + \dots + \left(\frac{n+1}{2}\right)^p \left(\frac{n-1}{2}\right) \\
&\quad + \left(\frac{n+1}{2}\right)^{p-2} \left(\frac{n-1}{2}\right)^2 + \left(\frac{n+1}{2}\right)^{p-3} \left(\frac{n-1}{2}\right)^2 + \dots + \left(\frac{n-1}{2}\right)^2 \\
&= \left(\frac{n-1}{2}\right) \sum_{i=p}^{k-1} \left(\frac{n+1}{2}\right)^i + \left(\frac{n-1}{2}\right)^2 \sum_{i=0}^{p-2} \left(\frac{n+1}{2}\right)^i \\
&= \left(\frac{n-1}{2}\right) \left(\frac{n+1}{2}\right)^p \frac{\left(\frac{n+1}{2}\right)^{k-p} - 1}{\left(\frac{n+1}{2}\right) - 1} + \left(\frac{n-1}{2}\right)^2 \frac{\left(\frac{n+1}{2}\right)^{p-1} - 1}{\left(\frac{n+1}{2}\right) - 1} \\
&= \left(\frac{n+1}{2}\right)^p \left(\left(\frac{n+1}{2}\right)^{k-p} - 1\right) + \left(\frac{n-1}{2}\right) \left(\left(\frac{n+1}{2}\right)^{p-1} - 1\right) \\
&= \left(\frac{n+1}{2}\right)^k - \left(\frac{n-1}{2}\right) - \left(\frac{n+1}{2}\right)^{p-1}
\end{aligned}$$

This function is exponential in p , with a negative coefficient, thus it is minimal at $p = k$ (see Figure 7). The minimum is so small relative to the rest of the function, that $HB(Pr_k) + HB(Pr_i) < HB(Pr_p) + HB(Pr_q)$ for any i and $p, q \neq k$, since even

$$(HB(Pr_k) + HB(Pr_1)) - (HB(Pr_{k-1}) + HB(Pr_{k-1})) = -\left(\frac{n+1}{2}\right)^{k-1} + 2\left(\frac{n+1}{2}\right)^{k-2} - 1 < 0.$$

Thus for any permutation π ,

$$\min_{1 \leq p \leq k} \{HB_{\min}(Pr_{\pi(p)}) + HB_{\min}(Pr_p)\} = \min\left\{ \begin{aligned} &HB_{\min}(Pr_k) + HB_{\min}(Pr_{\pi(k)}), \\ &HB_{\min}(Pr_k) + HB_{\min}(Pr_{\pi^{-1}(k)}) \end{aligned} \right\},$$

and the maximum over all permutations π is

$$HB_{\min}(Pr_1) + HB_{\min}(Pr_k).$$

This means that one of the best permutations is the reverse permutation, and the spread achieved by merging the minima and the maxima sequences using the reverse ordering of the coordinates is

$$n^k - 1 - (HB_{\min}(Pr_1) + HB_{\min}(Pr_k)) = n^k - 1 - n \left(\left(\frac{n+1}{2}\right)^{k-1} - 1 \right)$$

when n is odd. When n is even, the middle lines are of the type $(i_1, \dots, *, \dots, i_k)$ where all the coordinates equal $\lfloor (n-1)/2 \rfloor$ or $\lceil (n-1)/2 \rceil$. Since the arrangement for the maxima sequence uses the reverse order of the coordinates,

$$HB_{\max}(i_1, \dots, *, \dots, i_k) = n^k - 1 - HB_{\min}(n - i_k - 1, \dots, *, \dots, n - i_1 - 1).$$

Thus the maximum difference occurs in lines with the first half of the coordinates being $\lceil (n-1)/2 \rceil$ (ignoring the $*$), and the last half of the coordinates being $\lfloor (n-1)/2 \rfloor$. (If k is even, then if $*$ is in the first half of the coordinate values, there are more floors than ceilings, and if $*$ is in the last half, then there are more ceilings than floors). Thus the lower bound on the spread is

$$\begin{aligned} & HB_{\max}\left(\underbrace{\left\lceil \frac{n-1}{2} \right\rceil, \dots, \left\lceil \frac{n-1}{2} \right\rceil}_{\lceil (k-1)/2 \rceil}, \underbrace{\left\lfloor \frac{n-1}{2} \right\rfloor, \dots, \left\lfloor \frac{n-1}{2} \right\rfloor}_{\lfloor (k-1)/2 \rfloor}, n-1\right) - HB_{\min}\left(\underbrace{\left\lceil \frac{n-1}{2} \right\rceil, \dots, \left\lceil \frac{n-1}{2} \right\rceil}_{\lceil (k-1)/2 \rceil}, \underbrace{\left\lfloor \frac{n-1}{2} \right\rfloor, \dots, \left\lfloor \frac{n-1}{2} \right\rfloor}_{\lfloor (k-1)/2 \rfloor}, 0\right) = \\ & n^k - 1 - \left(HB_{\min}\left(0, \underbrace{\left\lfloor \frac{n-1}{2} \right\rfloor, \dots, \left\lfloor \frac{n-1}{2} \right\rfloor}_{\lfloor (k-1)/2 \rfloor}, \underbrace{\left\lceil \frac{n-1}{2} \right\rceil, \dots, \left\lceil \frac{n-1}{2} \right\rceil}_{\lceil (k-1)/2 \rceil}\right) + HB_{\min}\left(\underbrace{\left\lceil \frac{n-1}{2} \right\rceil, \dots, \left\lceil \frac{n-1}{2} \right\rceil}_{\lceil (k-1)/2 \rceil}, \underbrace{\left\lfloor \frac{n-1}{2} \right\rfloor, \dots, \left\lfloor \frac{n-1}{2} \right\rfloor}_{\lfloor (k-1)/2 \rfloor}, 0\right) \right) = \end{aligned}$$

If n is even, this equals to

$$\begin{aligned} & n^k - 1 - \left(HB_{\min}\left(0, \underbrace{\frac{n}{2}, \dots, \frac{n}{2}}_{\lfloor (k-1)/2 \rfloor}, \underbrace{\frac{n-2}{2}, \dots, \frac{n-2}{2}}_{\lceil (k-1)/2 \rceil}\right) + HB_{\min}\left(\underbrace{\frac{n}{2}, \dots, \frac{n}{2}}_{\lceil (k-1)/2 \rceil}, \underbrace{\frac{n-2}{2}, \dots, \frac{n-2}{2}}_{\lfloor (k-1)/2 \rfloor}, 0\right) \right) = \\ & n^k - 1 - \left(\left(\frac{n}{2} \right)^{\lceil \frac{k+1}{2} \rceil} \sum_{i=1}^{\lfloor \frac{k-1}{2} \rfloor} \left(\left(\frac{n}{2} \right) + 1 \right)^i + \left(\frac{n-2}{2} \right)^{\lfloor \frac{k-1}{2} \rfloor} \sum_{i=1}^{\lceil \frac{k-1}{2} \rceil} \left(\left(\frac{n-2}{2} \right) + 1 \right)^i + \right. \\ & \left. \left(\frac{n}{2} \right)^{\lfloor \frac{k+1}{2} \rfloor + 1} \sum_{i=0}^{\lceil \frac{k-1}{2} \rceil - 1} \left(\left(\frac{n}{2} \right) + 1 \right)^i + \left(\frac{n-2}{2} \right)^2 \sum_{i=0}^{\lfloor \frac{k-1}{2} \rfloor - 1} \left(\left(\frac{n-2}{2} \right) + 1 \right)^i \right) = \\ & n^k - 1 - \left(\left(\frac{n}{2} \right)^{\lceil \frac{k+1}{2} \rceil} \left(\frac{n+2}{2} \right) \frac{\left(\frac{n+2}{2} \right)^{\lfloor \frac{k-1}{2} \rfloor} - 1}{\left(\frac{n+2}{2} \right) - 1} + \left(\frac{n-2}{2} \right) \left(\frac{n}{2} \right) \frac{\left(\frac{n}{2} \right)^{\lceil \frac{k-1}{2} \rceil} - 1}{\left(\frac{n}{2} \right) - 1} + \right. \\ & \left. \left(\frac{n}{2} \right)^{\lfloor \frac{k+1}{2} \rfloor + 1} \frac{\left(\frac{n+2}{2} \right)^{\lceil \frac{k-1}{2} \rceil} - 1}{\left(\frac{n+2}{2} \right) - 1} + \left(\frac{n-2}{2} \right)^2 \frac{\left(\frac{n}{2} \right)^{\lfloor \frac{k-1}{2} \rfloor} - 1}{\left(\frac{n}{2} \right) - 1} \right) = \\ & n^k - 1 - \left(\left(\frac{n}{2} \right)^{\lceil \frac{k-1}{2} \rceil} \left(\frac{n+2}{2} \right) \left(\left(\frac{n+2}{2} \right)^{\lfloor \frac{k-1}{2} \rfloor} - 1 \right) + \left(\frac{n}{2} \right) \left(\left(\frac{n}{2} \right)^{\lceil \frac{k-1}{2} \rceil} - 1 \right) + \right. \\ & \left. \left(\frac{n}{2} \right)^{\lfloor \frac{k+1}{2} \rfloor} \left(\left(\frac{n+2}{2} \right)^{\lceil \frac{k-1}{2} \rceil} - 1 \right) + \left(\frac{n-2}{2} \right) \left(\left(\frac{n}{2} \right)^{\lfloor \frac{k-1}{2} \rfloor} - 1 \right) \right) \end{aligned}$$

When k is odd, this simplifies to

$$n^k + n - 2 - \left(\frac{n}{2} \right)^{\frac{k-1}{2}} \left((n+1) \left(\frac{n+2}{2} \right)^{\frac{k-1}{2}} - 2 \right),$$



Figure 8: The pattern created by the algorithm in (a) two and (b) three dimensions. The shaded part is filled with the herringbone arrangement for minima sequence, the other half is filled with the arrangement for maxima sequence.

and when k is even, this simplifies to

$$n^k + n - 2 - \left(\frac{n}{2}\right)^{\frac{k-2}{2}} \left(\frac{n+2}{2}\right) \left(n \left(\frac{n+2}{2}\right)^{\frac{k-2}{2}} - 1\right).$$

We have shown that the merging of the two Herringbone arrangements, the minima and the maxima, gives the spread of:

$$\begin{aligned} n^k - 1 - n \left(\left(\frac{n+1}{2}\right)^{k-1} - 1\right), & \quad \text{if } n \text{ is odd,} \\ n^k + n - 2 - \left(\frac{n}{2}\right)^{\frac{k-1}{2}} \left((n+1) \left(\frac{n+2}{2}\right)^{\frac{k-1}{2}} - 2\right), & \quad \text{if } n \text{ is even, and } k \text{ is odd,} \\ n^k + n - 2 - \left(\frac{n}{2}\right)^{\frac{k-2}{2}} \left(\frac{n+2}{2}\right) \left(n \left(\frac{n+2}{2}\right)^{\frac{k-2}{2}} - 1\right), & \quad \text{if both } n \text{ and } k \text{ are even.} \end{aligned}$$

However, we cannot exactly merge the two Herringbone arrangements. We now present an algorithm that combines the two arrangements and preserves the spread calculated for the merging. Since the lower bound and the merging bound coincide for the two dimensional matrices, the algorithm is optimal for that case. In general, however, it is not optimal and just one of the possible generalizations of the two-dimensional case.

Algorithm HERRINGBONE:

1. Fill the initial diagonal half of the matrix (i_1, \dots, i_k) , $\sum_{j=1}^k i_j \leq \lfloor k \frac{n-1}{2} \rfloor$ up to and including the bisecting hyperplane perpendicular to the main diagonal with the herringbone arrangement for the minima sequence.
2. Fill the rest of the matrix with the herringbone arrangement for the maxima sequence, skipping the cells already filled.

Theorem 2. *HERRINGBONE produces an arrangement of a k -dimensional cube with dimensions of size n with the spread of*

$$\begin{aligned} n^k - 1 - n \left(\left(\frac{n+1}{2}\right)^{k-1} - 1\right), & \quad \text{if } n \text{ is odd,} \\ n^k + n - 2 - \left(\frac{n}{2}\right)^{\frac{k-1}{2}} \left((n+1) \left(\frac{n+2}{2}\right)^{\frac{k-1}{2}} - 2\right), & \quad \text{if } n \text{ is even, and } k \text{ is odd,} \\ n^k + n - 2 - \left(\frac{n}{2}\right)^{\frac{k-2}{2}} \left(\frac{n+2}{2}\right) \left(n \left(\frac{n+2}{2}\right)^{\frac{k-2}{2}} - 1\right), & \quad \text{if both } n \text{ and } k \text{ are even.} \end{aligned}$$

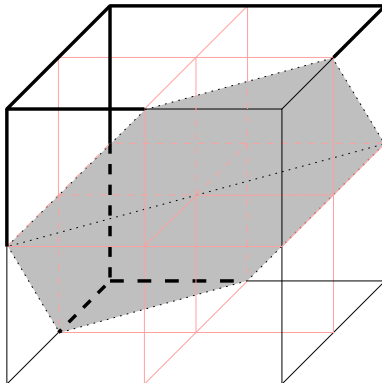

Figure 9: Dividing 3-dimensional matrix into 8 pieces. Thick lines show the parts where the border values come from the Herringbone arrangement for the minima sequence.

Proof. We shall assume for simplicity that n is odd. For even n the argument works in a similar way. We can divide the matrix into 2^k pieces by cutting through the middle of each face, including the middle line into both sides that are separated by it. For $k = 3$ see Figure 9. The initial and the last pieces, coordinate-wise, are entirely within the minima sequence and the maxima sequence arrangements, respectively. Now each line lies in two of the 2^k pieces. The central lines go through the initial and the last pieces. The spread in those lines is exactly the maximum difference between the minima and maxima Herringbone arrangements, as calculated above. We will show that the spread in any other line does not exceed that.

There are three types of lines that are not central lines:

- (a) lines that do not cross the bisecting plane,
- (b) lines that cross the bisecting plane and the endpoints are neither in the first or the last quadrant of the cube,
- (c) lines that cross the bisecting plane and one of the endpoints is either in the first or the last quadrant of the cube.

If a line does not cross the bisecting plane, then either its minimum is in the first quadrant or its maximum is in the last quadrant, since only the first and the last quadrants do not have the bisecting plane cutting through them. Without loss of generality, let the line lie completely in the minima arrangement half, and its minimum be in the first quadrant. Then the line's minimum is at most $\lfloor n/2 \rfloor^k$ away from the parallel central line's minimum, while it's maximum is at least $\lfloor (n/2)^k \rfloor - \lfloor n/2 \rfloor^k$ away from a central maximum. Thus the spread in the line is not greater than the spread in a central line.

The minimum in a line of type (b) is not in the first quadrant, therefore one of the coordinates if the minimum is greater than $\lceil n/2 \rceil$. As we have mentioned, Herringbone arrangement is a fully monotonic arrangement, the values increasing in the direction of increasing coordinates. Therefore the line's minimum is greater than the minimum in the parallel central line. Similarly, the line's maximum is less than the maximum in the parallel central line. Thus the difference between the line's maximum and minimum, the spread, is less than that in the parallel central line.

We will now consider a line of type (c). Without loss of generality we assume that the line's minimum is in the first quadrant. Thus the maximum is not in the last quadrant, since all the fixed coordinates of the points on the line are less than $\lceil n/2 \rceil$. Due to the full monotonicity of the Herringbone arrangement, both the minimum and the maximum in the line are less than those in the parallel central line. We will show that the difference between the central and the line's minimum is at least the difference between the maxima, thus making the spread in the line at most that in the central line. Moreover, we show that this is true for two lines of type (c) that differ in only one coordinate by 1, and the spread in the line closer to the central is at least the spread in the other line. Let a_t and a_{t+1} be the minima in these lines, and b_t , b_{t+1} be the

maxima, $t < \lfloor n/2 \rfloor$. Let $Corner(k, t)$ be the number of cells cut off the corner of size t of a k -dimensional cube. Then

$$a_{t+1} - a_t \leq (t+1)^k - t^k,$$

and

$$\begin{aligned} b_{t+1} - b_t &\geq (n-t)^k - Corner\left(k, \left(\left\lfloor \frac{n}{2} \right\rfloor - (t+1)\right)k\right) - \left((n-(t+1))^k - Corner\left(k, \left(\left\lfloor \frac{n}{2} \right\rfloor - t\right)k\right)\right) \\ &= (n-t)^k - (n-t-1)^k - \left(Corner\left(k, \left(\left\lfloor \frac{n}{2} \right\rfloor - t - 1\right)k\right) - Corner\left(k, \left(\left\lfloor \frac{n}{2} \right\rfloor - t\right)k\right)\right) \end{aligned}$$

Notice that

$$Corner(k, t) = \sum_{i_1=1}^t \sum_{i_2}^{i_1} \dots \sum_{i_{k-1}}^{i_{k-2}} i_{k-1} = \binom{t+k-1}{k},$$

Therefore

$$\begin{aligned} b_{t+1} - b_t &\geq (n-t)^k - (n-t-1)^k - \left(\binom{\left(\left\lfloor \frac{n}{2} \right\rfloor - t\right)k - k + k - 1}{k} - \binom{\left(\left\lfloor \frac{n}{2} \right\rfloor - t\right)k + k - 1}{k}\right) \\ &= (n-t)^k - (n-t-1)^k - \left(\binom{\left(\left\lfloor \frac{n}{2} \right\rfloor - t\right)k - 1}{k} - \binom{\left(\left\lfloor \frac{n}{2} \right\rfloor - t + 1\right)k - 1}{k}\right) \end{aligned}$$

Thus

$$\begin{aligned} (b_{t+1} - b_t) - (a_{t+1} - a_t) &\geq (n-t)^k - (n-t-1)^k - \left(\binom{\left(\left\lfloor \frac{n}{2} \right\rfloor - t\right)k - 1}{k} - \binom{\left(\left\lfloor \frac{n}{2} \right\rfloor - t + 1\right)k - 1}{k}\right) - ((t+1)^k - t^k) \\ &= ((n-t)^k - (n-t-1)^k) - ((t+1)^k - t^k) - \left(\binom{\left(\left\lfloor \frac{n}{2} \right\rfloor - t\right)k - 1}{k} - \binom{\left(\left\lfloor \frac{n}{2} \right\rfloor - t + 1\right)k - 1}{k}\right) \end{aligned}$$

$$t < \left\lfloor \frac{n}{2} \right\rfloor, \text{ therefore } ((n-t)^k - (n-t-1)^k) - ((t+1)^k - t^k) > 0$$

$$\binom{\left(\left\lfloor \frac{n}{2} \right\rfloor - t\right)k - 1}{k} < \binom{\left(\left\lfloor \frac{n}{2} \right\rfloor - t + 1\right)k - 1}{k}, \text{ therefore } -\left(\binom{\left(\left\lfloor \frac{n}{2} \right\rfloor - t + 1\right)k - 1}{k}\right) > 0$$

Thus

$$(b_{t+1} - b_t) - (a_{t+1} - a_t) \geq 0$$

and the maximum in a non-central line is further from a central maximum than the minimum in a non-central line from a central minimum. Therefore the spread in a line of type (c) is not greater than the spread in a central line.

We have shown that the maximum spread is achieved in the center and is as calculated above. \square

Corollary 2. *HERRINGBONE produces an arrangement of an n by n square with the spread of*

$$\frac{n(n+1)}{2} - 1$$

and is thus optimal for two dimensions.

So for a completely filled k -dimensional cube the spread is between the lower bound LB and the upper bound UB, where

$$\mathbf{LB} = n^k - 1 - \left\lfloor \left(\frac{kn^{k-1} + 2}{2k}\right)^{\frac{k}{k-1}} \right\rfloor - \left\lfloor \left(\frac{kn^{k-1}}{2k}\right)^{\frac{k}{k-1}} \right\rfloor$$

and

$$\mathbf{UB} = \begin{cases} n^k - 1 - n \left(\left(\frac{n+1}{2} \right)^{k-1} - 1 \right), & \text{if } n \text{ is odd,} \\ n^k + n - 2 - \left(\frac{n}{2} \right)^{\frac{k-1}{2}} \left((n+1) \left(\frac{n+2}{2} \right)^{\frac{k-1}{2}} - 2 \right), & \text{if } n \text{ is even, and } k \text{ is odd,} \\ n^k + n - 2 - \left(\frac{n}{2} \right)^{\frac{k-2}{2}} \left(\frac{n+2}{2} \right) \left(n \left(\frac{n+2}{2} \right)^{\frac{k-2}{2}} - 1 \right), & \text{if both } n \text{ and } k \text{ are even.} \end{cases}$$

This means that in a multiple descriptions system with all channels of equal capacity the distortion in case of one channel failure is between LB and UB. We address the case of more than one channel failing in Section 2.2.

2.2 Completely Filled Cube: Arbitrary Number of Channels Failing

In the previous section we have obtained the distortion in a multiple descriptions system with equal capacity channels for the case of one channel failing. We now consider the possibility of more than one channel failing. That is, we are concerned with the distortions D_{k+1} through D_{2^k-2} in the rate-distortion tuples $(\log n, \dots, \log n; 0, D_1, \dots, D_k, D_{k+1}, \dots, D_{2^k-2})$. In the number arrangement domain, we are concerned with designing an arrangement that minimizes the spread in any slice of any dimension.

Notice, however, that the herringbone arrangement maximizes and minimizes the smalls and bigs sequences, respectively, for any slice. Thus we can use the same construction for the algorithm.

The maximum error guaranteed by the algorithm in case of l channel failures is

$$b \left(\underbrace{\left\lfloor \frac{n-1}{2} \right\rfloor, \dots, \left\lfloor \frac{n-1}{2} \right\rfloor}_{\lfloor (k-l)/2 \rfloor}, \underbrace{\left\lfloor \frac{n-1}{2} \right\rfloor, \dots, \left\lfloor \frac{n-1}{2} \right\rfloor}_{\lfloor (k-l)/2 \rfloor}, \underbrace{*, \dots, *}_l \right) - a \left(\underbrace{\left\lfloor \frac{n-1}{2} \right\rfloor, \dots, \left\lfloor \frac{n-1}{2} \right\rfloor}_{\lfloor (k-l)/2 \rfloor}, \underbrace{\left\lfloor \frac{n-1}{2} \right\rfloor, \dots, \left\lfloor \frac{n-1}{2} \right\rfloor}_{\lfloor (k-l)/2 \rfloor}, \underbrace{*, \dots, *}_l \right),$$

which if n is odd, equals

$$n^k - 1 - \left(\left(\frac{n+1}{2} \right)^{k-l} - 1 \right) \frac{(n+1)^l + (n-1)^l}{2^l},$$

and if n is even, equals

$$n^k + n - 2 - \left(\left(\frac{n}{2} \right)^{\lfloor \frac{k-l}{2} \rfloor} \left(\frac{n+2}{2} \right)^l \left(\left(\frac{n+2}{2} \right)^{\lfloor \frac{k-l}{2} \rfloor} - 1 \right) + \left(\frac{n}{2} \right)^l \left(\left(\frac{n}{2} \right)^{\lfloor \frac{k-l}{2} \rfloor} - 1 \right) + \left(\frac{n}{2} \right)^{\lfloor \frac{k+l}{2} \rfloor} \left(\left(\frac{n+2}{2} \right)^{\lfloor \frac{k-l}{2} \rfloor} - 1 \right) + \left(\frac{n-2}{2} \right)^l \left(\left(\frac{n}{2} \right)^{\lfloor \frac{k-l}{2} \rfloor} - 1 \right) \right).$$

2.3 The Infinite Diagonal: $n_i = \infty, 1 \leq i \leq k, m = \infty$

We now would like to explore the achievable rate-distortion tuples of the type $(\log n, \log n, \dots, \log n, 0, D_1, \dots, D_{2^k-2})$ when the original information source is quantized into $m < n^k$ integers, where $\log n$ is channel rate. This means that in the corresponding matrix the m numbers do not fill the entire matrix. Vaishampayan [26], [25], [27] designed a solution for this case with two channels which is an arrangement of the numbers into a uniform diagonal. In the next section we examine this solution. However, to avoid the boundary effects, we will first consider the ‘‘infinite’’ diagonal in this section. We consider an arrangement of numbers in a infinite k -dimensional diagonal of thickness l , that is, any line in the diagonal has exactly l elements in it. This case is also equivalent to deriving the achievable rate-distortion tuples for an unbounded discrete information source and k channels of rate l .

Again, we will concentrate on the domain of number arrangement. We derive the lower bound on the spread in this case in a similar manner we did in Section 2.1 for the case of a complete cube. We use the herringbone arrangement again to maximize the smalls sequence and to minimize the bigs sequence. Since

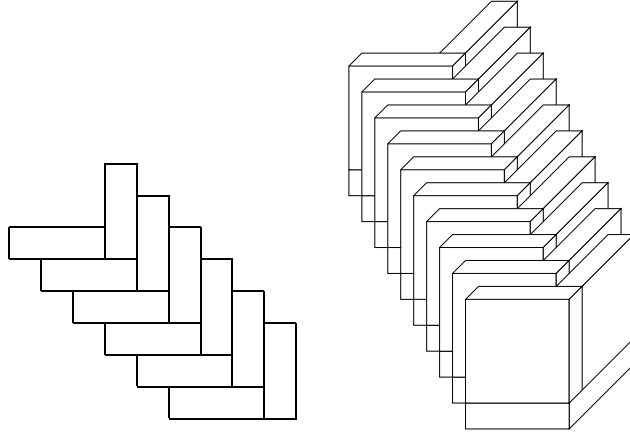

Figure 10: Uniform infinite diagonal herringbone arrangements in two and three dimensions.

the smalls and the bigs sequence arrangements can start at any point in the diagonal, we will consider the difference between the sequences relative to the starting points. The lower bound on the spread is the maximum over all lines of the difference between the smallest largest number and the largest smallest number. However, in this case this difference turns out to be constant.

Definition 2. A *herringbone arrangement* of a k -dimensional infinite l -diagonal is defined inductively as follows. Assign an arbitrary order to the coordinates of the system $\langle i_1, i_2, \dots, i_k \rangle$. A herringbone arrangement of k -dimensional 0-diagonal is empty. A herringbone arrangement of a 0-dimensional diagonal is any arrangement of one number in a cell.

Given a herringbone arrangement of the k -dimensional diagonal up to coordinate t_i in dimension i , we define a larger herringbone arrangement inductively:

- project the existing arrangement onto the $(k - 1)$ -dimensional hyperplanes $(*, \dots, *, t_i, *, \dots, *)$, limited to the diagonal,
- calculate the volume of each projection,
- recursively fill the largest volume projection (using coordinate order to break ties) with the herringbone arrangement for $k - 1$ dimensions.

We denote the element in the cell (i_1, \dots, i_k) of the k -dimensional herringbone arrangement by $HB_k(i_1, \dots, i_k)$. Examples of a herringbone arrangement of a diagonal are shown in Figure 10.

Lemma 2. *The herringbone arrangement of values in a k -dimensional diagonal maximizes the smalls sequence – the ascending list of the smallest numbers in a line – for that matrix. The proof is similar to the proof of Lemma 1.*

Corollary 3. *If the smallest number in line $(i_1, \dots, *, \dots, i_k)$ of the herringbone arrangement is a_j , then the smallest number in line $(i_1 + 1, \dots, *, \dots, i_k + 1)$ is*

$$a_j + \sum_{i=0}^{k-1} \lfloor l/2 \rfloor^i \lceil l/2 \rceil^{k-1-i} = \begin{cases} a_j + k(l/2)^{k-1}, & \text{if } l \text{ is even,} \\ a_j + \frac{(l-1)^k + (l+1)^k}{2^k}, & \text{if } l \text{ is odd.} \end{cases}$$

Similarly,

Corollary 4. *If the largest number in line $(i_1, \dots, *, \dots, i_k)$ of the herringbone arrangement is b_j , then the largest number in line $(i_1 + 1, \dots, *, \dots, i_k + 1)$ is*

$$b_j + \sum_{i=0}^{k-1} \lfloor l/2 \rfloor^i \lceil l/2 \rceil^{k-1-i} = \begin{cases} b_j + k(l/2)^{k-1}, & \text{if } l \text{ is even,} \\ b_j + \frac{(l-1)^k + (l+1)^k}{2^k}, & \text{if } l \text{ is odd.} \end{cases}$$

Thus, combining the results of Corollary 3 and Corollary 4, the difference $b_j - a_j$ remains constant along any diagonal. That is, the difference between the largest and the smallest numbers in line $(i_1, i_2, \dots, *, \dots, i_k)$ equals that of line $(i_1 + s, i_2 + s, \dots, *, \dots, i_k + s)$ for some integer s . To see this, notice that while we start the smalls arrangement from 0 at some point, since the diagonal is infinite, we can continue the arrangement in the other direction using increasingly smaller numbers. Similarly with the bigs arrangement, we can continue it in the direction of the increasing of coordinates using larger numbers. Thus the smalls and the bigs arrangements are the same arrangements, offset by a certain value. This arrangements are also “facing” opposite directions: the herringbone arrangement can be viewed as cones stacked into each other, and in case of the smalls sequence the “cones” face the direction of the coordinate decrease, while in the bigs sequence “cones” face the coordinate increase direction. However, the brims of these cones from both sequences coincide, and since that is where the smallest and the largest numbers in each line occur, the difference along any diagonal remains constant.

A consequence of the structure of the herringbone arrangement is the fact that the difference is maximized over the central diagonal. That is, if (t, t, \dots, t) is a cell in the center of the diagonal, then the maximum difference is achieved for any line $(t + s, t + s, \dots, *, \dots, t + s)$, where s is some integer, and equals to the difference

$$HB(t + \lfloor l/2 \rfloor, t, \dots, t) - HB(t - \lfloor l/2 \rfloor, t, \dots, t) = (\lfloor l/2 \rfloor - 1) \sum_{i=0}^{k-1} \lfloor l/2 \rfloor^i \lfloor l/2 \rfloor^{k-1-i} + \lfloor l/2 \rfloor^{k-1}.$$

2.4 The Incomplete Cube: $n_i = n, 1 \leq i \leq k; m \leq n^k < \infty$

Suppose we have an arbitrary quantity of $m \leq n^k$ numbers to be arranged in a $n \times \dots \times n$ k -dimensional cube. This corresponds to the information source being quantized into m integers, where $\log m$ is less than the combined channel rates. At first glance, the diagonal arrangement gives the least distortion. That is precisely the shape used by Vaishampayan in [26], [25], [27]. We show, however, that diagonal arrangement is not the best possible and a lower distortion is possible for these rates.

Consider a diagonal arrangement limited to the n^k cube. It is a restriction of an infinite diagonal, thus the bound on the spread is the same over the true diagonal part of the arrangement, away from the boundary effect. However, the boundary parts of the arrangement are complete cubes of size $\lfloor l/2 \rfloor^k$, and the spread there is the spread in a complete cube derived in Section 2.1. By comparing the two spreads, in the boundary cubic parts and in the diagonal part, we can show that the spread on the diagonal is always greater. Thus the spread is dominated by the diagonal part, as long as there is a true diagonal part. That is, if $l \leq n$, then there is at least one complete line in each dimension which belongs entirely to the diagonal, and the spread in this line dominates the overall spread in the matrix. But this means that we can increase the size of the initial cubic part, decrease the width of the diagonal part, thus decreasing the overall spread. Not only that, but we can decrease the spread even more by introducing non-overlapping cubic parts along the diagonal, thus, by balancing the entire structure, making all of the cubic part smaller. This construction is demonstrated in Figure 11. The spread in this arrangement is better than the diagonal. However currently we do not have a proof whether this arrangement is optimal or not.

Now, if $l > n$, then the initial cubic parts of the diagonal overlap. Remembering from Section 2.1, the maximum spread of the entirely filled cube is the spread in line $(\lfloor (n-1)/2 \rfloor, \dots, *, \dots, \lfloor (n-1)/2 \rfloor)$, which is a line in the intersection of the first-quadrant cube and the last-quadrant cube. Those are precisely the cubic parts of the diagonally filled cube. Since the spread of a cube optimally filled with $m < n^k$ numbers is at most the spread of the cube filled with n^k numbers, in the case of the overlapping cubic parts of the diagonal the spread is the the same as in a completely filled cube. However, once again, this proves only the upper bound on the optimal arrangement, not the lower bound.

3 Conclusions

We have studied the problem of multiple description scalar quantizers. We have considered the question of describing the achievable rate-distortion tuples. The problem has been formulated as a combinatorial

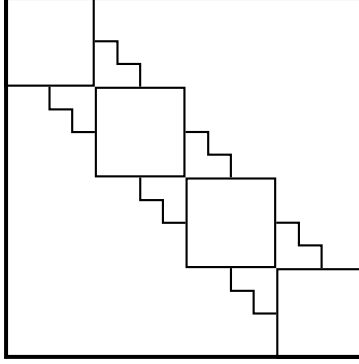

Figure 11: Possibly an optimal arrangement for for an incompletely filled cube.

optimization problem of arranging numbers in a matrix. It has been noted that this formulation is equivalent to a graph theory problem of finding minimal bandwidth of cartesian products of cliques.

We have proposed a technique for deriving lower bounds on the distortion at given channel rates. The approach is constructive thus allowing an algorithm that gives the first upper bound for the arbitrary number of channels. For the case of two communication channels with equal rates the bounds coincide thus giving the precise lowest achievable distortion at fixed rates. To the best of our knowledge, this is the first result concerning the system with more than two communication channels.

4 Acknowledgments

We would like to thank Sergio Servetto for bringing this problem to our attention, Douglas West for pointing out the relevance to the graph bandwidth problem and helpful suggestions, Ari Trachtenberg, Mitch Harris, Jeff Erickson, and Ralf Koetter for many fruitful discussions.

References

- [1] Ahlswede, R., “The rate-distortion region for multiple descriptions without excess rate”, *IEEE Transactions on Information Theory*, **31** (1985), 721–726.
- [2] Batllo, J- C. and V.A. Vaishampayan, “Multiple description transform codes with an application to packetized speech”, *IEEE International Symposium on Information Theory - Proceedings*, 1994, IEEE, Piscataway, NJ, USA.
- [3] Berger, T. and Z. Zhang, “Minimum breakdown degradation in binary source encoding”, *IEEE Transactions on Information Theory*, **29** (1983), 807–814.
- [4] Bezrukov, S. L., “Edge Isoperimetric Problems on Graphs”, *Graph Theory and Combinatorial Biology*, Balatonlelle 1996, Budapest 1999, 157–197.
- [5] Buzi, L., V.A. Vaishampayan and R. Laroia, “Design and asymptotic performance of a structured multiple description vector quantizer”, *IEEE International Symposium on Information Theory - Proceedings*, 1994, IEEE, Piscataway, NJ, USA.
- [6] Chinn, P. Z., J. Chvátalová, A.K. Dewdney, and N.E. Gibbs, “The Bandwidth Problem for Graphs and Matrices – A Survey”, *Journal of Graph Theory*, **6** (1982), 223–254.
- [7] El Gamal, A. A. and T.M. Cover, “Achievable rates for multiple descriptions”, *IEEE Transactions on Information Theory*, **28** (1982), 851–857.
- [8] Feige, U., “Approximating the bandwidth via volume respecting embedding”, *13th Annual ACM Symposium on Theory of Computing-Proceedings*, 1998, ACM, Dallas, TX, USA.
- [9] Gale, D. and R. Karp, “A phenomenon in the Theory of Sorting”, *Journal of Computer and System Sciences* **6**, 103-115 (1972)
- [10] Graham, R. L., D.E. Knuth and O. Patashnik, *Concrete Mathematics: A Foundation For Computer Science*, 2nd ed., Addison-Wesley, 1994.
- [11] Harper, L. H, “Optimal assignments of numbers to vertices”, *Journal of SIAM*, **12**, Vol.1, (March 1964), 131–135.
- [12] Harper, L. H, “Optimal Numberings and Isoperimetric Problems on Graphs”, *Journal of Combinatorial Theory*, **1** (1966), 385–393.
- [13] Harper, L. H, “On an isoperimetric problem for Hamming graphs”, *Discrete Applied Mathematics*, **95** (1999), 258–309.
- [14] Henrich, U. and M. Stiebitz, “On the Bandwidth of graph products”, *Journal of information processing and cybernetics*, **28** (1992) 113–125.
- [15] Jayant, N. S., “Subsampling of a DPCM speech channel to provide two self-contained half-rate channels”, *The Bell System Technical Journal*, **60** (1981), 501–501.
- [16] Jayant, N. S. and S.W. Christensen, “Effect of packet losses in waveform coded speech and improvements due to odd-even sample interpolation procedure”, *IEEE Transactions on Communications*, **29** (1981), 101–109.
- [17] Karpinski, M., J. Wirtgen and A. Zelikovsky, “An approximation algorithm for the bandwidth problem on dense graphs”, *ECCC TR97-017*.
- [18] Kloks, T., D. Kratsch and H. Muller, “Approximating the bandwidth for asteroidal triple-free graphs”, *Algorithms-ESA '95, Paul Spirakis (Ed.), Lecture Notes in computer Science 979*, 434–447.
- [19] Lawler, E. L., *Combinatorial optimization : networks and matroids*, New York : Holt, Rinehart and Winston, 1976.

- [20] Nakano, K., “Linear layout of generalized hypercubes”, *Proceedings of WG’93, Lecture Notes in Computer Science* **790**, Springer Verlag, 1994, 364–375.
- [21] Ozarow, L., “On a source coding problem with two channels and three receivers”, *The Bell System Technical Journal*, **59** (1980), 1909–1921.
- [22] Shannon, C. E., “Coding theorems for discrete source with fidelity criterion”, *IRE National Convention Record*, **4** (1959), 142–163.
- [23] Vaishampayan, V. A., “Vector quantizer design for diversity systems”, in *Proceedings of 25 Annual Conference on Inform. Sci. Syst.*, Johns Hopkins University, Mar. 20–22, 1991, 564–569.
- [24] Vaishampayan, V. A., “Design of multiple description scalar quantizers,” *IEEE Transactions on Information Theory*, **93** (1993), 821–834.
- [25] Vaishampayan, V. A. and J. Domaszewicz, “Design of entropy-constrained multiple-description scalar quantizers”, *IEEE Transactions on Information Theory*, **40** (1994), 245–250.
- [26] West, D. B., *Introduction to Graph Theory*, Prentice Hall, 1996.
- [27] West, D. B., personal communication.
- [28] Witsenhausen, H. S. and A.D. Wyner, “Source coding for multiple descriptions II: A binary source”, *The Bell System Technical Journal*, **60** (1981), 2281–2292.
- [29] Wolf, J. K., A.D. Wyner and J. Ziv, “Source coding for multiple descriptions”, *The Bell System Technical Journal*, **59** (1980), 1417–1426.
- [30] Yang, S.- M. and V.A. Vaishampayan, “Low-delay communication for Rayleigh fading channels: an application of the multiple description quantizer”, *IEEE Transactions on Communications*, **43** (1995), 2771–2783.
- [31] Zhang, Z. and T. Berger, “New results in binary multiple description”, *IEEE Transactions on Information Theory*, **33** (1987), 502–521.